

THE STRONGEST.

6270 TERRUS CVT ■ 6300 TERRUS CVT



STEYR
TRAKTOREN

Your partner to rely on.



STEYR

CVT



**BECAUSE YOU DEDICATE YOUR
ENERGIES FULLY TO YOUR WORK,
YOU NEED A TRACTOR THAT IS
STRONGER THAN ANY OF THE OTHERS.**



**MACHINE
OF THE YEAR 2016**



CONTENTS

6-7 THE TERRUS CVT SERIES

8-15 CAB AND CONTROLS

18-19 ENGINE

20-21 CVT TRANSMISSION

22-23 PTO

24-25 HYDRAULICS

26-27 AXLES, BRAKES, ABS

30-31 S-TECH

32-33 S-TECH 700 MONITOR

34-35 EASY-TRONIC II AND ISOBUS III

36-37 DEALERS AND SERVICE

38 MAINTENANCE

39-41 TECHNICAL DATA



STRONG, STRONGER, TERRUS

Our engineers have gone to extraordinary lengths to build a tractor that really does have what it takes to deliver stupendous performance. The outcome: The Terrus CVT, the new flagship of STEYR.

There is a choice of two models, equipped with ultra-efficient and reliable ECOTECH engines, one rated for 271 hp and the other for 300 hp. With its ideal power-to-weight ratio, the Terrus CVT is predestined for rapid transport duties as well as for heavy-duty field work. This, our most powerful tractor, also has other strengths - in particular exceptional levels of comfort: A spring-mounted front axle combined with a luxurious and remarkably quiet cab make work a relaxed and fatigue-free activity. Also on board: the very latest technologies, such as S-TECH, S-GUIDE, ISOBUS III and Easy-Tronic II, as well as S-Fleet. Gigantic power delivered - the new TERRUS CVT.



A SUPERLATIVE POWER PACK



Low noise emission level of 69 dB(A) to take the stress out of working, and for using the telephone in hands-free mode.

LED

Up to 20 LED worklights for perfect 360° illumination.



Ergonomic operation using the Multicontroller armrest.



Cab and front axle suspension for more comfort.

IIIS-TRONIC

S-TRONIC for automatic control of the driving strategy.

IIIECOTECH
MEHR LEISTUNG, WENIGER DIESEL

ECOTECH for more power and less diesel consumption.

CVT

Continuously variable transmission with ultimate mechanical efficiency rating.



50 km/h achieved at a fuel-efficient 1,600 rpm.



Active stop control for stopping on a steep slope without a brake.



Headland management Easy-Tronic II for the automation of work operations, dependent on time and distance covered.



4 rear PTO speeds and 2 speeds at the front, each with Power mode, or with the fuel-efficient speed of the Eco mode.



Maximum rear lift capacity of up to 11,058 kg, and of 5,821 kg at the front.



Payload of up to 5,500 kg facilitates individual ballasting and the use of heavy devices.



Intelligent anti-lock braking system with many additional functions.



4-wheel brake with Opti-Stop.



Tyre and wheel combinations for every application including double tyres at front and rear.



Terrus CVT supports ISOBUS II and the latest ISOBUS III technology.



S-TECH Precision farming - always just ahead of the pack.

The image shows the interior of a tractor cab from the driver's perspective. The view is dominated by a large window looking out onto a rural landscape with green fields and a line of trees under a blue sky with light clouds. The tractor's interior features a black seat with a red and white striped backrest, a steering wheel with a yellow horn button, and a central console. A side mirror is visible on the left, reflecting the rear view. The text is overlaid on the upper portion of the image in white, bold, sans-serif font, set against a dark red background.

**BECAUSE YOU ALREADY HAVE
ENOUGH TO CONTEND WITH, YOU
DESERVE A MACHINE THAT LETS
YOU KEEP AN EYE
ON ALL OF IT.**



IT DOESN'T GET MORE COMFORTABLE!

The Terrus CVT cab offers a working area you can rely upon fully in all situations: A low noise level of only 69 dB(A), ergonomic seating and steering wheel adjustments, finely adjustable air conditioning and our sophisticated suspension and lighting system ensure maximum comfort.

FULL WORKING POWER UP FRONT The Deluxe cab with tinted windows, sun roller blinds on front and rear windscreens and the precision control on the automatic air-conditioning system enables you to keep a cool head at all times. A big filter in the ventilation system keeps the cab supplied with fresh air. For added convenience, the steering column comes with height and rake adjustment, and the electrically adjustable Multicontroller armrest can be adapted to suit the driver perfectly. Optimum comfort is assured by the Dual-Motion seat

with dynamic damping system, pivot-mounted headrest and active carbon inserts to control humidity. On the comfortable, upholstered co-driver's seat, even big adults have plenty of space. A leather steering wheel and a cab floor carpet create a working environment in which you automatically feel comfortable.

ACTIVE SUSPENSION The Maximo Evolution leather-upholstered, heated driver's seat with cooling ventilation and active suspension with automatic adjustment satisfies the most demanding of requirements. To match this, the Active Luxury cab also features a leather-upholstered co-driver's seat.



TAKE YOUR SEAT IN FIRST-CLASS.

- Low noise level of 69 dB(A)
- Generously proportioned luxury cab with 5-stage adjustment to cab suspension.
- A choice of 2 seat options with alcantara or leather covers
- Tinted windows
- Sun roller blind on front and rear windscreens
- Automatic air-conditioning system
- Hi-fi stereo system with Bluetooth hands-free unit



PERFECT 360° ALL-ROUND VISIBILITY

- 4-pillar panorama cab
- High-visibility roof window
- Electrically adjustable, heated wide-angle mirrors.
- Up to 20 LED worklights





BEAUTIFUL TO BEHOLD, GREAT TO LOOK OUT FROM.

With its 4-pillar panorama cab with its large windows, its high-visibility roof window and a one-piece front windscreen, you have perfect and unrestricted all-round visibility. The LED work light package assures superlative visibility even after night has fallen. Standard equipment comprises 6 LED work lights at the front of the roof, another 6 at the back of the roof, and 4 more LED work lights on the bonnet. An optional 4 LED work lights, one fitted low on each cab pillar, front and rear, are also available. The light intensity of 2,000 lumens per LED headlight turn night into day and ensure accurate, efficient work.

GREAT OVERVIEW The slimline bonnet provides optimum visibility over the front working area. The Terrus CVT also provides unobstructed rear visibility over the tool-mounting areas for effortless attachment of implements. With the large, electrically adjustable and heated telescopic mirrors with wide-angle insert, you can even keep an eye on wide attachments. An additional window in the roof provides unobstructed visibility upwards.



THE TERRUS CVT COCKPIT.

In the comfortable Terrus CVT cockpit, you are the boss. The ergonomically designed cab is equipped with the very latest control elements, and with inno-

vative instruments. These enable you to control and monitor all functions and operations very easily.



- 1 Multicontroller**
- 2 Shuttle forwards/reverse**
- 3 Selection of speed range**
- 4 Operation of remote valves**
- 5 Raising/lowering of rear and front hitch, Float setting**
- 6 Speed controller**
- 7 Easy-Tronic II activation**
- 8 S-TECH 700: the integrated touchscreen colour monitor**
- 9 Tractor and performance monitor**
The tractor and performance monitor is integrated in the right-hand A pillar in the natural field of view of the driver. It delivers the most important items of performance information at a glance.
- 10 Electric joystick**
for up to 4 remote valves
- 11 Operation of the electr. remote valves**
- 12 Front PTO on/off**
- 13 Rear PTO on/off**
- 14 Eco-Drive™ operating lever**
with split manual throttle
- 15 ICP – Intuitive Control Panel**
- 16 EHR position control**
- 17 EHR traction control**
- 18 EHR raising/lowering of rear hitch**
- 19 Vibration damping of rear hitch**
- 20 Rear PTO management**
- 21 Slip control on/off**
- 22 Easy-Tronic II headland management**
- 23 All-wheel drive and differential lock management**
- 24 Two constant engine speed memory units**
- 25 Front hitch position control**
- 26 Front PTO management**
- 27 Raising/lowering front hitch**
- 28 CVT transmission functions**
- 29 Control of the electronic remote valves**
- 30 Slip control setting**
- 31 Lowering speed control on front hitch**
- 32 Lifting height restriction on front hitch**
- 33 Lowering speed control on rear hitch**
- 34 Lifting height restriction on rear hitch**
- 35 Response sensitivity of rear hitch**
- 36 Park inhibit**



**BECAUSE YOU GIVE OF YOUR BEST
DAY IN, DAY OUT, YOU DESERVE
TECHNOLOGY ON WHICH YOU CAN
DEPEND EVERY SECOND
OF EVERY DAY.**





ECOTECH AT A GLANCE

- 6-cylinder engine with variable turbocharger and intercooler
- Hi-eSCR exhaust technology: highly efficient SCR system (selective catalytic reduction)
- Long maintenance intervals (600 operating hours) for the engine
- High maximum engine torque of up to 1,282 Nm
- Up to 32% torque increase
- EU exhaust standard, stage IV
- S-TRONIC engine/transmission management
- Individual adaptation of driving strategy
- Reversible fan
- Option of a high-performance engine back-pressure brake
- Large tank capacity of 630 litres of diesel and 96 litres of AdBlue



GREAT POWER, LOW FUEL CONSUMPTION.

The electronically controlled diesel engines in the Terrus CVT range cover a nominal performance range of 271 to 300 hp. A turbocharger with variable geometry delivers prompt response characteristics and great power even at low engine speeds.

ECOTECH
MEHR LEISTUNG, WENIGER DIESEL.

PREMIER LEAGUE ENGINE TECHNOLOGY. Power used most intelligently. Thanks to ECOTECH the engines in the Terrus CVT models are all the best in their class. Here, profitability, productivity, environmental preservation and ultra-modern energy management come together in perfect symbiosis. By virtue of the unique Hi-eSCR exhaust gas after-treatment system, fuel consumption is optimised and power and engine response are improved. Optimum fuel injection time without exhaust gas recirculation means neither the engine nor the cooling system are overloaded. This makes maintenance intervals of 600 a reality. The system also does not require a particle filter, and this reduces maintenance costs.



GEPRÜFTE EFFIZIENZ. Wie unabhängige Tests der DLG (Deutsche Landwirtschafts-Gesellschaft) zeigen, ist der Terrus CVT unglaublich effizient: nur 249g/kWh Kraftstoffverbrauch im DLG-PowerMix!

HIGH-PERFORMANCE ENGINE BACK-PRESSURE BRAKE. A high-performance engine back-pressure brake is available as a cost option. This delivers a 40% increase in braking performance by stopping the delivery of fuel, closing the exhaust flap and setting the engine fan and eVGT turbocharger to maximum resistance. This reduces brake wear on the tractor and on a braked implement attachment or trailer.

ALWAYS READY FOR OPERATION. The cooling system always ensures that the engine is at its optimum operating temperature. The optional reversible fan enables the direction of air flow to be reversed. This simply blows out impurities on the ventilation grille, cleaning it automatically. On the reversible fan with infinitely variable fan blades, the blade angle can be adjusted to suit the amount of cooling action required, making it highly while at the same time increasing fuel efficiency.

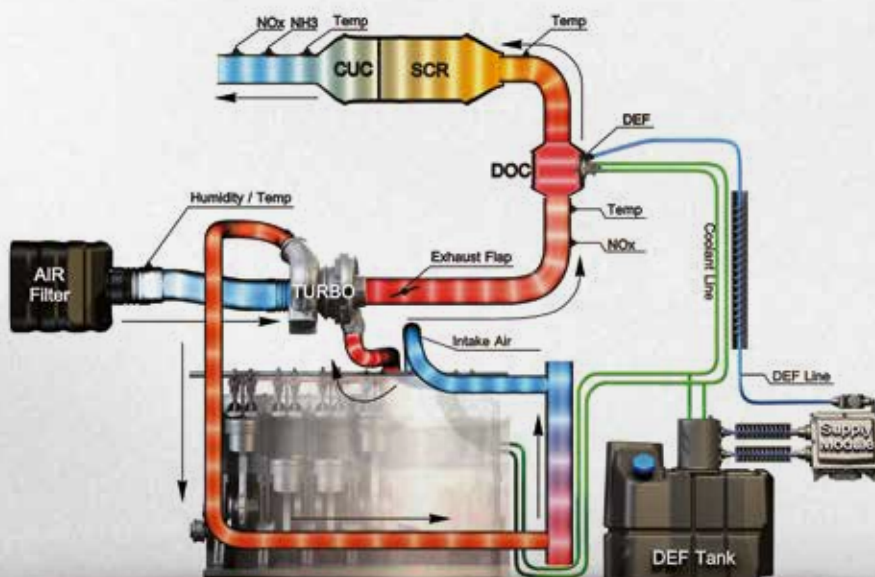

TERRUS CVT DRIVE:

- Continuously variable from 0 to 50 km/h
- Active stop control
- DKT - double-clutch technology
- S-TRONIC engine-transmission management
- 50 km/h at 1,600 rpm for optimised fuel consumption





EFFORTLESSLY AND CONTINUOUSLY VARIABLE.

Everything always runs smoothly with the continuously variable transmission design (CVT). An intelligent interplay of hydraulic and mechanical components assures economy, without having to concede any power delivery. The continuously variable ratio enables you to tackle every task effortlessly.

HIGH MECHANICAL EFFICIENCY RATING. The CVT transmission assures a high proportion of mechanical drive force and/or a low component of hydrostatic power transmission. Based on this design principle, engine power is used to the maximum. The S-TRONIC controls the transmission ratio and engine speed to suit power requirements and automatically assures optimum fuel efficiency. The CVT control logic, as required, delivers the right response characteristics for the transmission. A choice of 3 levels can be set on the accelerator pedal. Together with the tractor-trailer brake when a trailer is being towed, this improves safety during retardation, preventing the trailer from shunting the tractor. This means that the entire system is adapted perfectly at all times to suit prevailing operating conditions.

EFFICIENT POWER TRANSFER The rugged transmission unit with double-clutch technology assures superlative power transmission. Working without traction interruption means improved acceleration and reduced fuel consumption.

ECONOMICAL AND COMFORTABLE The gear ratio is automatically adjusted to suit the desired vehicle speed and the engine speed always remains in the optimum range. That also save fuel.



Continuously variable transmission from 0 to 50 km/h.



Double-clutch technology DKT™

POWERFUL DRIVE AT BOTH ENDS.

The PTO on the Terrus CVT series transmits engine power to a maximum efficiency level. The rear-mounted PTO with 4 speed settings and the optional front-mounted 2-speed PTO shaft deliver their rated speed of 1000 rpm even at engine speeds as low as 1853 rpm. In PTO economy mode, these PTO speeds are even achieved at engine speeds of less than 1600 rpm. That means you not only save fuel, but also protect the engine and the environment.

PERFECTLY MATCHED. The easy-to-operate PTO management function reduces workload by automatically engaging and disengaging the PTO when the front and rear hydraulics are being raised and lowered. The soft-start controller enables the attachments to be started up gently. The PTO shaft is available as standard with a 6 and a 21-tooth spline. A more powerful 20-tooth spline can also be supplied. Integration of the front-mounted PTO and front hitch at the front of the tractor makes it possible to reduce the distance between front axle and front hitch. The front hitch then has two readily accessible pairs

of hydraulic plug-in connectors with depressurised return action, as well as a socket receptacle and an ISOBUS connection.



- 1 Control lever for front PTO on/off
- 2 Control lever for rear PTO on/off
- 3 Rear PTO management
- 4 Front PTO management



External actuation for rear PTO, rear hitch and a control unit for each of the rear mudguards.



Easy to reach: External actuation of front hitch, front PTO and front control unit.



EFFICIENT TRANSMISSION OF ENGINE POWER

- 4-stage rear PTO 540/540E/1000/1000E
- 2-stage front PTO 1000/1000E
- Perfectly integrated front and rear PTO
- PTO management for front and rear PTO
- Front connection options ideally located to suit the requirements of every implement

AS STRONG AS AN OX: STEYR PRECISION HYDRAULICS.

Our load sensing hydraulic system is based on an axial piston variable displacement pump with a flow rate of up to 223 l/min. The infinitely variable setting of the flow rates for up to 8 individual consumers reliably ensures that the right amount of fluid is available everywhere at the same time. This guarantees excellent response from the entire working hydraulic system.

MAKING LIGHT WORK OF HEAVY LOADS With a maximum lift capacity of up to 11,058 kg, the Terrus CVT makes light work of every job.

MORE COMFORT AND SAFETY. Attachments can be set precisely using the electronic hitch control (EHR) by means of potentiometers or touchscreen monitor. The dynamic vibration cancellation system 'Ride Control' neutralises the vibrations from heavy attachments. Automatic lower links stabilisers ensure safety in headland turns and during transport.

SAFETY WITH A HEAVY IMPLEMENT:

- Modern load-sensing hydraulics
- High maximum lift capacity for up to 11,058 kg
- Precise hitch control
- 'Ride Control' dynamic vibration damping.
- Optimum setting on any terrain

RAPIDLY READY FOR OPERATION. Implements can be attached quickly and easily using external buttons on both rear mudguards that operate the rear hitch and the hydraulic upper link as well as the rear PTO.

- Programmable hydraulic functions
- The multi-controller provides a free choice of control unit operation, and it can be set up using the S-Tech 700 monitor
- Power-Beyond connections
- Front hitch ex factory with lift capacity of up to 5,821 kg







Automatic all-wheel drive and differential lock management

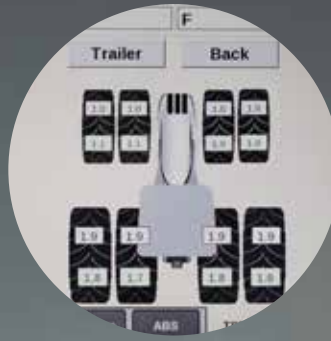

Tyre pressure control

On the S-Tech 700 monitor you can keep an eye on the tyre pressures of up to 16 tyres - on the tractor as well as on the trailer.



Ball-head coupling

The K80 ball-head coupling is ideal for heavy-duty trailer operation. It is retractable, height-adjustable and can be removed to make the PTO shaft more accessible. The K80 can absorb a thrust load of up to 4 tons, thereby utilising the load capacity of wheels and rear axle to an optimum level.



POWERFUL AND SAFE

- Front axle suspension
- 4WD and 4-wheel braking deliver even more braking power
- Electronic parking brake secures the tractor and trailer automatically whenever the driver's seat is vacated
- Option of ABS for enhanced safety
- ABS steering brake auxiliary functions and automatic ABS steering brake
- Ballasting dependent on application, up to 2,000 kg at the front and up to 1,182 kg with wheel weights
- Tyre and rim combinations for every application including double tyres at front and back



MAKES DRIVING A REAL PLEASURE.

Terrus CVT: The modern way of driving a tractor. All models deliver conviction with their reactive steering system and high payloads, which extend up to 5500 kg. They are all fitted with wet dual disk brakes (4 disk brakes on the rear axle). Specifically in heavy-duty transport, these HD brake discs, being more resistant to wear, deliver a longer service life. The perfect interplay of all components ensures a unique new-generation driver experience.

OUTSTANDING MANOEUVRABILITY The slimline design of the front chassis and the central driveline facilitate a steering lock of 55% and a turning radius of just 7.7 metres.

EXCELLENT DRIVE CHARACTERISTICS. The active front axle suspension on the Terrus CVT models react with the help of an acceleration sensor - depending on parameters such as the position of the lifting gear, braking characteristics and acceleration - always optimum.

SYSTEMATIC BRAKING Ultra-sensitive sensors check the wheel speeds. The ABS system controls braking operations in such a way that the wheels do not lock. This assures direct transmission of braking and lateral guidance forces to the road surface at all times - which means full steering integrity is maintained.



TURNS THAT PROTECT THE SOIL The additional function of an 'ABS steering brake' releases the brake briefly on the inside wheel during a turn. This prevents damage to the soil in the headlands. With the S-Tech monitor the system sensitivity level can be set to suit all conditions individually.

EVEN MORE MANOEUVRABLE. The ABS steering brake can also be activated automatically by turning the steering wheel to a lock position. This protects the soil even during the tightest of turning manoeuvres, also making them very comfortable for the driver.

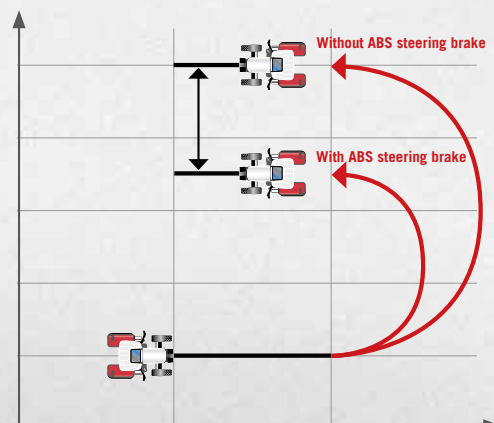

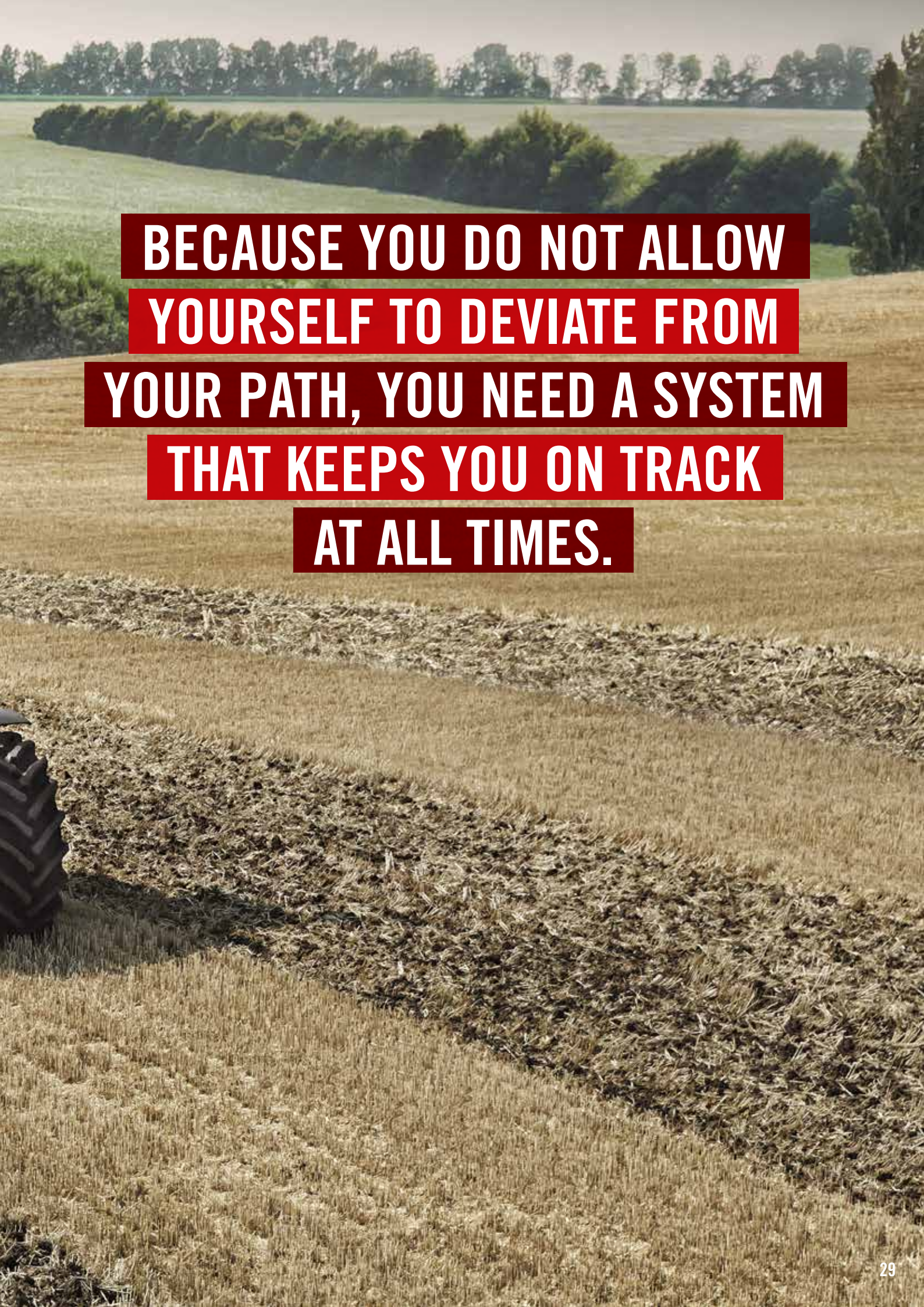

A tractor is plowing a field, creating a long, straight furrow in the soil. The field is golden-brown, indicating it has been harvested. In the background, there are rolling green hills and a line of trees under a clear sky. The text is overlaid on the image in white, bold, sans-serif font, with each line of text on a separate red rectangular background.

**BECAUSE YOU DO NOT ALLOW
YOURSELF TO DEVIATE FROM
YOUR PATH, YOU NEED A SYSTEM
THAT KEEPS YOU ON TRACK
AT ALL TIMES.**

THE COMPLETE S-TECH PACKAGE IN EVERY TERRUS CVT EX-FACTORY!

This includes: :

- S-TECH 700 monitor with touchscreen
- ISOBUS II and III function
- S-Guide steering system



ULTIMATE PRECISION, MORE CONTROL.

STEYR S-TECH.



S-TECH revolutionises agriculture. Lane guidance, data management, integrated communication between attachments and the tractor by means of ISOBUS III function, and a great deal more. Our modular S-TECH system controls the entire production cycle. Welcome to the future of modern agriculture!

ABSOLUTELY PRECISE. The automatic, DGPS-based steering system S-Guide works to ultimate standards of precision. It guarantees parallel lane guidance when working on straight tramlines and curves. With a reproducible accuracy of up to 2.5 cm (RTK+) there is no risk of overlapping or gaps even under tough ground or weather conditions, including when working in the dark or low light. As well as GPS, signals from the GLONASS satellites are also used. To achieve the highest levels of precision, these satellite signals are automatically fine-tuned using correction data from the ground station via mobile wireless network.

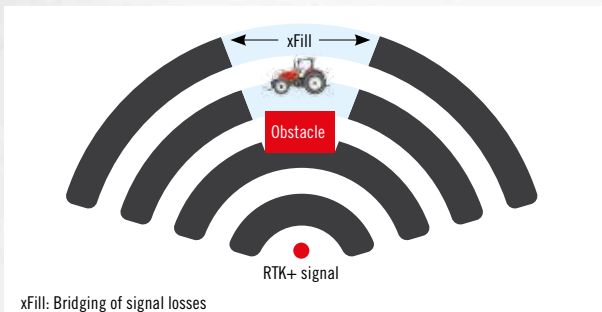

xFill: Bridging of signal losses

INDIVIDUAL SOLUTIONS. There are various equipment variants of the S-TECH with different levels of precision. From the simple retrofit solution with the GPS-base EZ pilot up to the integrated and fully-equipped S-Guide with the S-TECH 700 touch-screen monitor that can even be moved between different vehicles on your farm. Just have a word with your STEYR consultant about your requirements. Together with you, your dealer will find an S-TECH solution to suit your wishes perfectly.



XFILL DELIVERS TRAMLINE PRECISION EVEN WITH A POOR SIGNAL. With the standard xFill technology available as standard in all RTK+ solutions, signal losses lasting up to 20 minutes can be bridged.

STEYR S-FLEET TELEMATICS SOLUTIONS This system makes it possible in real-time to call up the operational data from your vehicles via the wireless network. This enables machine fleet managers to stay in touch with their machines and drivers and send and receive real-time data. This increases productivity and facilitates optimum fleet organisation.

EVERYTHING IN SIGHT, EVERYTHING UNDER CONTROL: THE S-TECH 700 MONITOR

ALL IMPORTANT FUNCTIONS AND DATA ON ONE TOUCHSCREEN STEYR Terrus CVT tractors fitted with S-TECH meet every requirement for precision agricultural technology. This means, for instance, that controlling ISOBUS II and III-compatible attachments, the integration of automatic steering systems and the use of Terrus CVT tractors are all easily possible. The armrest-integrated S-TECH 700 monitor is easily controlled via a touchscreen. There is the option of having it mounted on an adjustable rail in the right-hand side window. Through automation of all core functions of the tractor, your S-TECH monitor delivers optimum operational procedures and also provides you with an overview of the work already completed, fuel consumption levels and much, much more.

THE S-TECH 700 TOUCHSCREEN MONITOR

■ **Performance monitoring** Recording of total performance, daily performance and individual operations. All data can be saved to a USB pen drive from the S-TECH monitor or, using S-FLEET telematics with data transfer function, can even be transmitted by wireless to the office for analysis purposes.

■ **Vehicle settings:** A range of S-TECH displays enables settings to be adjusted - e.g. flow rate control and time control for the electronic control units. Assignment of control elements on the electronic control units can be defined individually to suit each attachment. Settings for different attachments and working conditions are saved, e.g. the EHR rear hitch setting. For example, if next time you attach a plough, all you have to do is select the correct set-up - and off you go!

■ **Easy-Tronic II headland management system:** This facilitates the automation of operating procedures and increases the impact and daily performance levels of tractor and driver.

■ **Compatible with ISOBUS Class II and III:** ISOBUS-compatible devices are connected up and the user interface is then displayed on the S-TECH monitor. This enables the device to be controlled easily and interactively via the monitor in the cab without the need for a separate control element and without additional wiring.

■ **Video input:** With up to three video cameras (e.g. on the back of a forage wagon / self-loading trailer or bale press), live images can be monitored. That means you always know what is happening behind you without having to look away from the working area.



- 1 Assign buttons to the control units
- 2 Determine flow rates and time control
- 3 Compatible with ISOBUS Class II and II

EFFICIENT, USER-FRIENDLY AND PRECISE:

- Intuitive S-TECH 700 touchscreen monitor
- Performance monitoring
- Vehicle settings
- ISOBUS II and III
- Easy-Tronic II headland management
- Video input



RELAXED AND PRODUCTIVE

Easy-Tronic II headland management

- Automation of the work sequences of rear and front-mounted implements on headlands and many other areas of application
- Recording and programming while in operation or while stationary
- Programming possible, dependent on time, distance and event initiation.
- Calling up of sequences by Multicontroller, S-TECH 700 monitor or ICP
- Simple retrospective adjustment of sequences

ISOBUS Class II:

- as well as displaying implement settings (Class I), facilitates the operation and control of these implements using the ex-factory S-TECH 700 touchscreen monitor
- on ISOBUS Class II-capable devices, there is no longer any need for an additional control element.



ISOBUS Class III enables the attached implement to control the tractor:

- Raising/lowering the hitch
- PTO start/stop speed
- Control commands for remote valves
- Tractor speed for optimum utilisation

AUTOMATION PERFECTED.

The headland management system Easy-Tronic II provides fully automated work operations when executing turns on the field, and in many other areas of application. The Class III ISOBUS system raises the exchange of operational and control data between tractor and attachment to a new level. It expands possibilities and as a result considerably increases productivity and profitability. It does this by enabling tractor operation to be controlled by the attachment.

DRIVER RELIEF. The Easy-Tronic II headland management system is designed to relieve the workload of the driver when performing headland turns and during many other control-related tasks. Each working step can be programmed either by time or by distance covered. Not only that, but additional trigger points can be set for various other automated functions. Examples of this include the lowering of engine speed after an attachment has been raised. A headland sequence can either be programmed while the vehicle is in motion, or while it is stationary. Reproduction of this headland sequence can either be performed automatically or manually, and can be initiated either by the Multicontroller, on the S-TECH 700 monitor or on the ICP.. Changes to the steps stored can be made easily and at any time on the S-TECH monitor.

TRACTOR CONTROLLED BY THE ATTACHED IMPLEMENT. In contrast to the Class I and II versions of ISOBUS, in which the S-TECH 700 monitor displays the settings of the implement or can also enable the implement to be controlled by the monitor, ISOBUS Class III enables the attached implement to control the tractor. This means that tractor functions are operated by the attached implement. For example, the front hitch can position itself autonomously, the PTO shaft can be switched on and off, the control units can be actuated and the vehicle speed can be adapted to suit prevailing conditions. This results in each attachment functioning flawlessly, and above all, it relieves workload and strain for the driver.

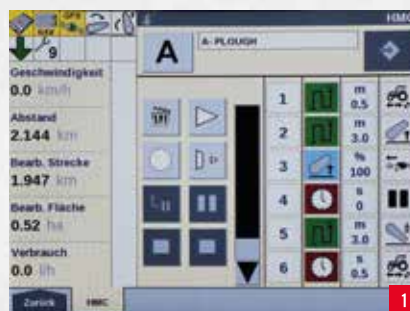

1 Easy-Tronic II headland management



2 ISOBUS Class II compatibility:



ALWAYS THERE FOR YOU.

GOOD SERVICE IS CLOSE BY: YOUR LOCAL STEYR DEALER. Our tractors are designed for thousands of hours of hard work, and are remarkably easy to maintain and service. You can obtain all the spare parts and service support you need from your STEYR dealer. Your local dealer is also your first point of contact for maintenance and warranty support.

///MAXSERVICE

MAXIMUM SERVICE: MAX SERVICE. Safe operation without downtime periods: With STEYR MAX Service you can call on expert local help seven days a week and right around the clock. Our 24-hour emergency service supports you with specialist personnel, products and spare parts, and can be reached on the freefone / toll-free number 00800 7839 7000.



FINANCING MADE EASY: CNH INDUSTRIAL CAPITAL. An expert partner is essential when you are financing your STEYR tractor. We recommend CNH Industrial Capital. This agricultural and construction vehicle financing expert can offer you a range of services – from individually tailored loans, leasing and rental offers to credit cards and even financing for tooling or rental. CNH Industrial Capital endeavours to find the financing option best suited to your new investments, the requirements of your farm and your financial position. Also, with the proven CNH Industrial Capital cover letter, which provides peace of mind in the event of a machine breakdown and/or related repair costs, you not only reduce your investment risk but you also have more planning security.



EVERYTHING YOU NEED. The complete range of spare parts and components can be found at your local STEYR dealer. Here, you also have access to STEYR-trained service personnel who can look after your tractor in a highly professional manner. The key to the maximum number of problem-free operating hours.

MAKE IT EASY FOR YOURSELF: MAINTENANCE WORK.



Comfortable tank filling.



Effortless inspection of vee belt.



Checking of oil level and topping up without lifting the bonnet



Continuous cleaning via a Piclon filter ensures that the filter only needs to be maintained when the corresponding warning lamp lights up.



One-section bonnet support by gas struts can be lifted into two positions (45°/90°), even with a front-mounted attachment.



Fast and simple cleaning of the radiator and air-conditioning system.



PERFORMANCE THROUGH INNOVATION

ENGINE PERFORMANCE OF THE STEYR 6300 TERRUS CVT

- 1 Max. engine power at 1,800 rpm = 230 kW (313 hp)
- 2 Rated engine power at 2,100 rpm = 221 kW (300 hp)

Torque raise = 28%

A Max. torque at 1,400 rpm = 1,282 Nm

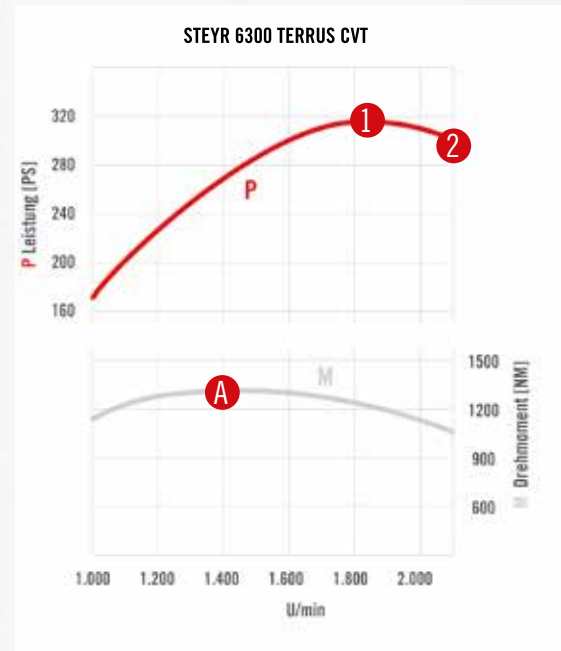

STEYR TERRUS CVT DIMENSIONS: Model-specific

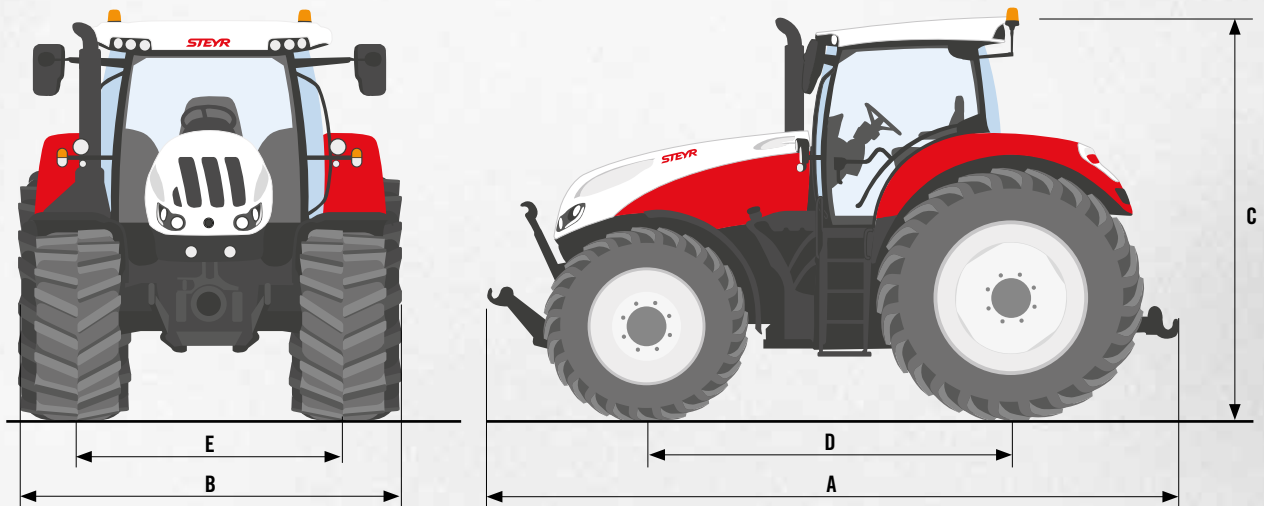

DIMENSIONS ¹⁾	6270 TERRUS CVT, 6300 TERRUS CVT
A Max. length/ B Min. width / C Total height [mm]	5,700 / 2,536 / 3,265
D Wheelbase [mm]	2,995
E Track width front / rear [mm]	1,858 - 2,258 Flange axle: 1,840 – 2,052 / adjustable bar axle: 1,840 - 2,374

¹⁾ with standard tyres

MODEL		ENGINE			
STEYR TRAKTOREN	Vehicle speed*	Max. engine power ECE R120 ³⁾ [kW/hp]	Engine speed at max. engine power [rpm]	Max. torque	OECD torque raise [%]
	Continuously variable transmission 0 – 50 km/h ECO or 0 – 40 km/h ECO	Rated engine power ECE R120 ³⁾ [kW/hp]	Rated engine speed [rpm]	[Nm @ 1,400 rpm]	
6270 TERRUS CVT	■	212 / 288 199 / 271	1,800 2,100	1.194	32
6300 TERRUS CVT	■	230 / 313 221 / 300	1,800 2,100	1.282	28

MODEL	HYDRAULICS					
STEYR TRAKTOREN	EHR hitch control with dynamic Ride Control vibration damping	Max. pump flow stand- ard/optional [l/min]	Max. operating pressure [bar]	Max. lift capacity [kg]	Max. 5 electri- cal rear-remote valves	Max. 3 electrical midmounted remote valves
6270 TERRUS CVT	■	165 PFC / 223 PFC	215	11,058	□	□
6300 TERRUS CVT	■	165 PFC / 223 PFC	215	11,058	□	□

MODEL	BRAKES	TYRES	WEIGHT
STEYR TRAKTOREN	Wet dual brake disks, hydraulically actuated	Maximum tyres ²⁾	Min. weight [kg]*/ permitted gross vehicle weight [kg]
	All-wheel brake* with Opti-Stop	Front	
	Two-line compressed air braking system*	Rear	
6270 TERRUS CVT	■	650/60R34 710/75R42	10,500 / 16,000
6300 TERRUS CVT	■	650/60R34 710/75R42	10,500 / 16,000

■ Standard □ Optional — Not available

		PTO			
Cylinder / cubic cc [cm ³] / type	Fuel tank Diesel / AdBlue [l]	Optional electro-hydraulic system with PTO management			
		PTO speed [rpm]	Engine speed [rpm]	PTO shaft spline	Front PTO speed* @ engine speed [rpm]
		6 / 6,728 / Common rail diesel engine with 24 valves, turbocharger and inter-cooler, stage IV	540/540E/1,000/1,000E		
■	630 / 96	■	■	1 3/8" 21-splines 1 3/8" 6-splines 1 3/4" 20-splines	□
■	630 / 96	■	■	1 3/8" 21-splines 1 3/8" 6-splines 1 3/4" 20-splines	□

		ALL-WHEEL DRIVE	ABS	FRONT AXLE/STEERING			
Hydraulic linkage	Lift capacity front hitch* [kg]	Electro-hydraulic shift action with traction management	Anti-lock braking system	Suspended front axle	Steering system / steering wheel Hydraulic load-sensing system / height-adjustable and tilt-adjustable	Steering lock, track width 1,930 mm [°]	Min. turning circle radius ¹⁾ track width 1,930 mm [m]
Cat III/IVN with high-speed tail hook	5,821	■	□	■	■	55	7.7
Cat III/IVN with high-speed tail hook	5,821	■	□	■	■	55	7.7

CAB



Deluxe cab

Spring-mounted luxury cab with climate control system and an interior noise level of just 69 dB(A).
 Leather steering wheel. dual-motion driver's seat with alcantara cover, comfortable co-driver's seat with safety belt.
 Electrically adjustable Multicontroller armrest with ICP (intuitive control panel) and joystick. S-TECH 700 monitor and ISOBUS II connection.
 Tinted windows, rear window can be opened, roof window, sun roller blind on rear window and cab floor carpeting.
 Windscreen wipe-wash system, LED worklights in roof at front and back and central control console for the worklights.

Active Luxury cab*

Like the Deluxe cab, with the addition of: Maximo Evolution leather driver's seat, active suspension with automatic adjustment, with heating & ventilation, leather co-driver's seat and leather steering wheel.

¹⁾ with standard tyres

²⁾ Other tyres available as cost options on request

³⁾ ECE R120 corresponds to ISO 14396 and 97/68EC * Depending on country-specific legislative requirements and specifications



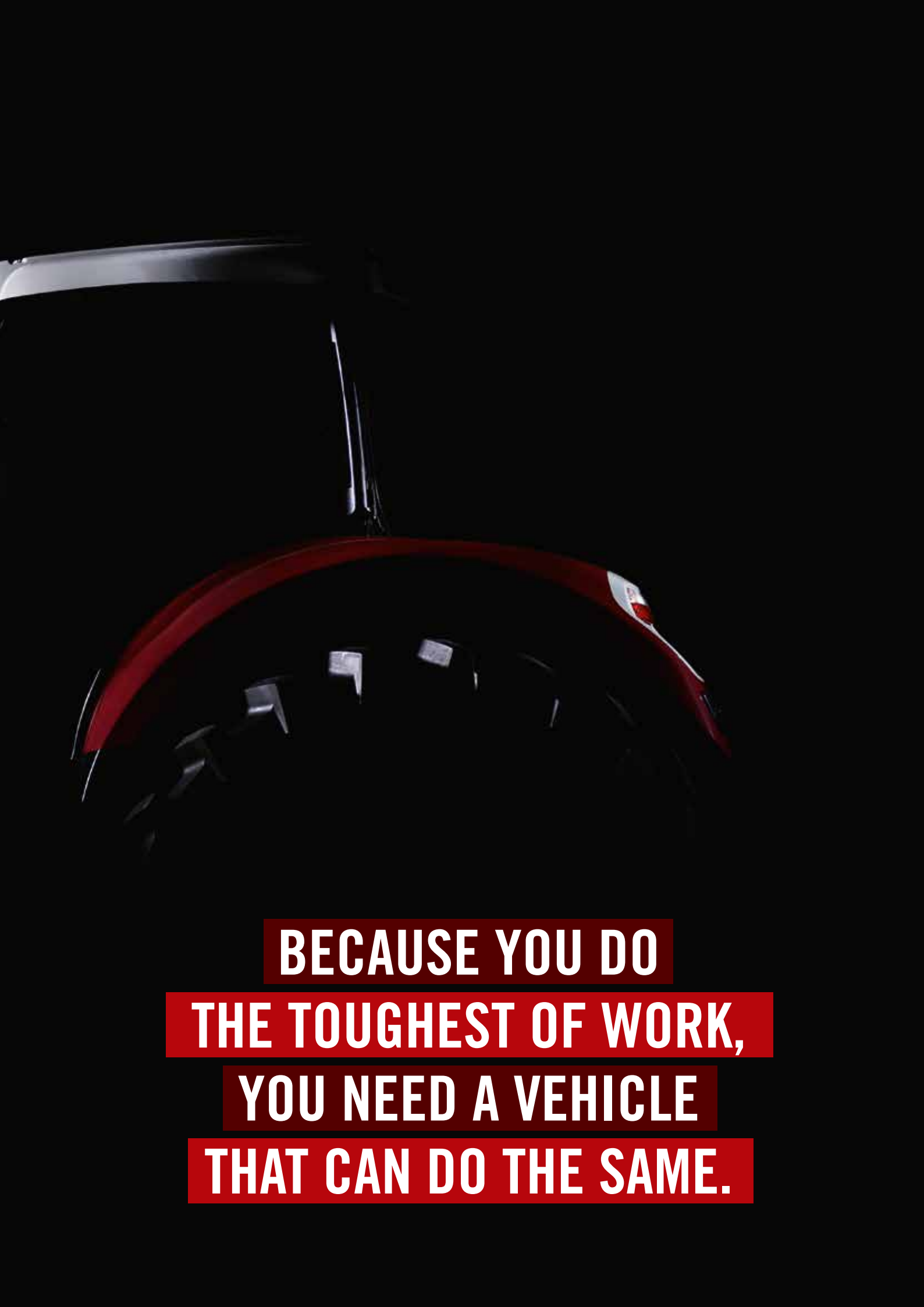

**BECAUSE YOU DO
THE TOUGHEST OF WORK,
YOU NEED A VEHICLE
THAT CAN DO THE SAME.**

a partner company of
STEYR
TRAKTOREN

STEYR-traktoren.com
facebook.com/STEYRtractors

Without doubt you drive better. Before using this vehicle, please read the Operating Manual and become familiar with the use of each of the controls. Note the contents of the instruction panels and use the safety equipment for your own personal safety. This brochure is intended for use internationally. The availability of a few models and of standard and special equipment items may vary from one country to another. STEYR reserves the right at any time and without prior announcement to make changes to the design and technical version without this in any way obliging STEYR to transfer these to units already sold.

Details, descriptions and pictorial material reflect the current status at the date of publication, but can be amended without prior announcement and at any time. Pictorial materials may show certain national versions, items of special equipment as well as non-complete standard versions.

TP01 / SM / 11.15 / Printed in Austria – Cod. n. 15S0002COMINB – www.STEYR-traktoren.com

