

**TRINCIATRICE PIEGHEVOLE**  
**BROYEUR PLIANT - STALK SHREDDER**  
**KLAPPBARES MULCHGERÄT - TRITURADORA PLEGABLE**

**READY**









**49.52 N**

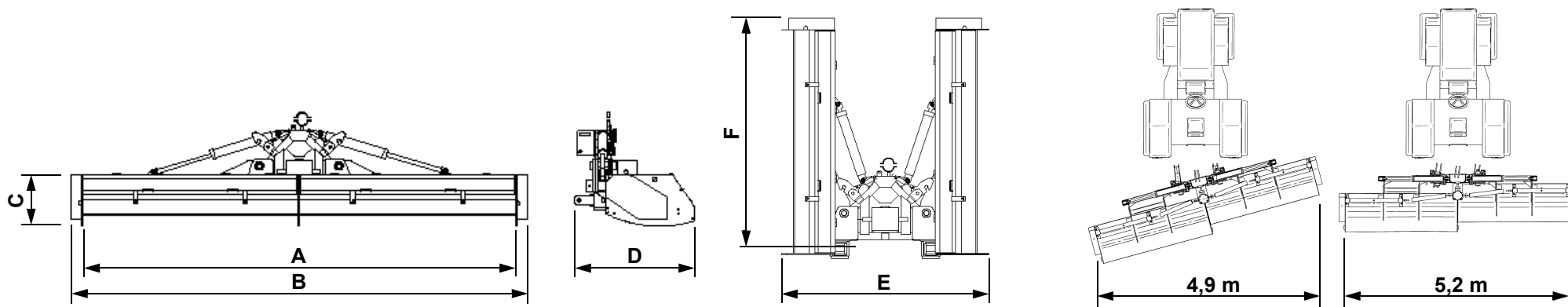

**Agrimaster**<sup>®</sup>

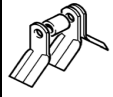
Via Nobili 44  
40062 MOLINELLA (BO) - Italy  
Tel. (051) 882701 - Fax (051) 882542  
e-mail: commerciale@agrimaster.eu  
www.agrimaster.it

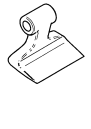

Modello Modèle Model Modell Modelo	A	Potenza minima trattore <i>Puissance minimale tracteur</i> Minimum tractor power <i>Traktormindestleistung</i> Potencia mínima tractor			 kg max				 KPT		B	C	D	E	F
		cm	kW												
<b>READY 49.52 N</b>	520	103	140	1000	1820	144	48+96	48	48	10	554	65	159	240	270

**Dotazione di serie - Equipement de série - Standard equipment - Serienzubehör - Incluido en la serie:**

- Attacco a tre punti categoria 2 - *Attelage à trois points de 2<sup>ème</sup> catégorie* - Three-point-hitch Cat. 2 - *Drei-Punkt-Anbau Kat. 2* - Conexión a tres puntas categoría 2.
- Scatola ingranaggi con ruota libera (103 kW/140 CV a 1000 giri/min) - *Boîtier avec roue libre (103 kW/140 CV a 1000 tours/min)* - Gearbox with free-wheel (103 kW/140 HP - 1000 rpm) *Getriebe mit Freilauf (103/140 PS-1000 U/min)* - Caja engranajes con rueda libre (103 kW/140 CV a 1000 rev/min).
- Accumulatore oleopneumatico sui martinetti di apertura - *Accumulateur oléopneumatique sur les vérins d'ouverture* - Oleopneumatic accumulator on the opening jacks - *Druckluftspeicher auf Öffnungsheböcke* - Acumulador oleopneumático sobre martinetes de apertura.
- Ganci idraulici di sicurezza per posizione chiusa in trasporto - *Crochets hydrauliques de sûreté pour la position fermée en transport* - Hydraulic safety hooks for closing position during transport - *Hydraulische Sicherheitshaken für Transportstellung* - Ganchos hidráulicos de seguridad para posición cerrada en transporte.
- Rullo posteriore ø194 - *Rouleau arrière ø194* - Rear roller ø194 - *Heckwalze ø194* - Rodillo posterior ø194.
- Cardano tipo 8 L=1100 - *Cardan type 8 L=1100* - Type 8 cardan joint L=1100 - *Typ 8 Gelenkwelle L=1100* - Cardan tipo 8 L=1100.

Modello - <i>Modèle</i> - Model - <i>Modell</i> - Modelo	Prezzo - <i>Prix</i> - Price - <i>Preis</i> - Precio
<b>READY 49.52 N</b>	